



## BELLOW VALVE WITH REGADA ACTUATOR zBEL



Body material	Nominal pressure	Nominal diameter	Max. temperature
A Grey cast iron	C 16 bar	DN 15-150	300°C
C Nodular cast iron	C 16 bar D 25 bar	DN 15-150 DN 15-150	350°C













correspond to the pressure equipment directive 2014/68/UE marking CE for DN≥32

### FEATURES

- leakproofness class - A acc. EN -12266 – 1 type 01
- leakproofness class IV acc. PN-EN 60534-4 type 71
- environment-friendly
- tests acc. EN - 12266 - 1
- flanges drilled according to EN 1092-2
- face-to-face dimension according to EN 558-1 series 1

### APPLICATION \*

\* not all of the applications are suitable for all of the executions

industries							
	INDUSTRY	SHIPBUILDING INDUSTRY	HEATING	REFRIGERATION AND AIR CONDITIONING			
	media						
		GLYCOL	INDUSTRIAL WATER	DIATHERMIC OIL	STEAM	COMPRESSED AIR	NEUTRAL FLUIDS

Data given can be changed without notice.

Edition 01/2018

MATERIALS, DIMENSIONS

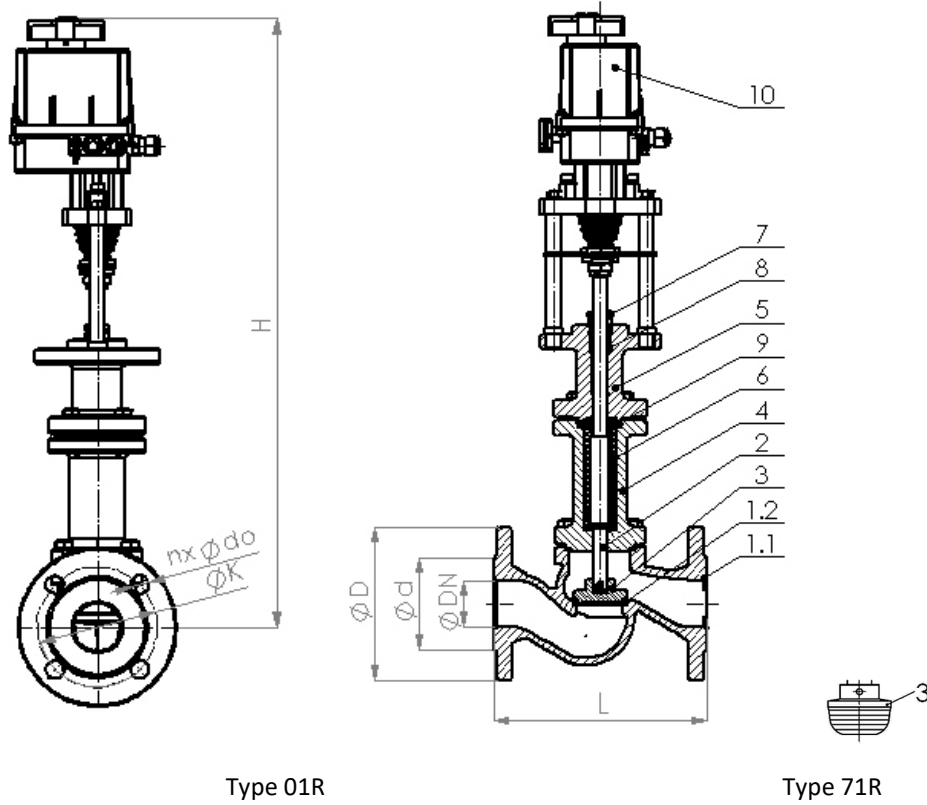

Type 01R

Type 71R

	Body material	A	C
	Type	01R; 71R	
1.1	Body	EN – GJL-250 5.1301 (ex. JL1040)	EN – GJS-400 – 18-LT 5.3103 (ex.JS1025)
1.2	Seat ring	X20Cr13 1.4021	
2	Stem	X20Cr13 1.4021	
3	Disc	X20Cr13+QT 1.4021	
4	Bonnet I	EN – GJS-400 – 18-LT 5.3103 (ex.JS1025)	
5	Bonnet II	EN – GJS-400 – 18-LT 5.3103 (ex.JS1025)	
6	Bellow	X6CrNiMoTi17-12-2	
7	Gland	Carbon steel	
8	Gland packing	Graphite	
9	Gasket	Graphite	
10	Actuator	REGADA	
	Max. temperature	300°C	350°C

Data given can be changed without notice.

Edition 01/2018

ZETKAMA Sp. z o.o.  
Ul. 3 Maja 12  
PL 57-410 Ścinawka Średnia

Tel. +48 74 8652 193  
Tel. +48 74 8652 111  
Fax +48 74 8652 199

E-mail export@zetskama.com.pl  
www.zetskama.com

DN	15	20	25	32	40	50	65	80	100	125	150
L (mm)	130	150	160	180	200	230	290	310	350	400	480
H (mm)											
STO STR OPA 4kN	582,5	582,5	587,5	597,5	617,5	623,5	---	---	---	---	---
STO1 STR01 PA 6,3kN	---	---	---	---	779	785	839	837	873	939	961
ST2 STR2PA 14kN	---	---	---	---	---	---	914	912	948	1014	1036
ST2 STR 2PA 17kN	---	---	---	---	---	---	914	912	948	1014	1036
ST2 STR 2PA 21,5kN	---	---	---	---	---	---	---	912	948	1014	1036

**PRESSURE-TEMPERATURE RATINGS**

	PN		-10°C÷120°C	150°C	200°C	250°C	300°C	350°C
EN-GJL-250	16	bar	16	14,4	12,8	11,2	9,6	---
EN-GJS-400-18 LT	16		16	15,5	14,7	13,9	12,8	11,2
	25		25	24,3	23	21,8	20	17,5

**MAX PERMISSIBLE CLOSING PRESSURES (on flow to open P2=0)**

ACTUATOR	DN										
	15	20	25	32	40	50	65	80	100	125	150
STO STR OPA 4kN	25	25	25	17,9	14,2	8,8	---	---	---	---	---
STO1 STR01 PA 6,3kN	---	---	---	---	25	17,4	11,5	8,1	5,6	3,5	2,5
S12 STR2PA 14kN	---	---	---	---	---	---	25	18,1	12,4	7,8	5,7
ST2 STR 2PA 17kN	---	---	---	---	---	---	25	22	15,1	9,5	6,9
ST2 STR 2PA 21,5kN	---	---	---	---	---	---	---	25	19,1	12	8,7

Data given can be changed without notice.

Edition 01/2018

FLANGE DIMENSIONS ACC. PN-EN 1092-2

DN		15	20	25	32	40	50	65	80	100	125	150
PN16	D (mm)	95	105	115	140	150	165	185	200	220	250	285
	K (mm)	65	75	85	100	110	125	145	160	180	210	240
	nxd (mm)	4x14	4x14	4x14	4x19	4x19	4x19	4x19	8x19	8x19	8x19	8x23
PN25	D (mm)	95	105	115	140	150	165	185	200	235	270	300
	K (mm)	65	75	85	100	110	125	145	160	190	220	250
	nxd (mm)	4x14	4x14	4x14	4x19	4x19	4x19	8x19	8x19	8x23	8x28	8x28

Data given can be changed without notice.

Edition 01/2018

TYPE

Figure	Body material	Nominal diameter	Nominal pressure	Type
234	A Grey cast iron EN-GJL-250	15-150 mm	C 16 bar	stop valve 01R
		15-150 mm	C 16 bar	control valve 71R
234	C Nodular cast iron EN-GJS-400-18-LT	15-150 mm	C 16 bar	stop valve 01R
		15-150 mm	C 16 bar	control valve 71R
		15-150 mm	D 25 bar	stop valve 01R
		15-150 mm	D 25 bar	control valve 71R

ORDERING

Figure	Body material	Nominal diameter	Nominal pressure	Type
234	A Grey cast iron EN-GJL-250	15-150 mm	C 16 bar	stop valve 01R

Order example acc. index

234 A 150 C 01R

Bellow valve with REGADA actuator  
 Grey cast iron EN-GJL-250  
 Nominal diameter (mm)  
 Nominal pressure PN 16  
 Stop valve

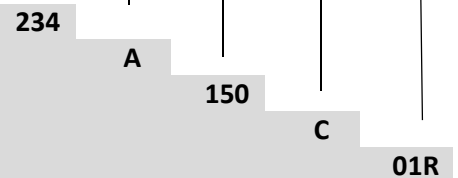

Data given can be changed without notice.

Edition 01/2018